



E-S4 – User Manual

Original Instructions



Keep this document for future reference!



Revision log

Date	Rev	Change description	By	Appr.
2019-06-26	00	Initial release	LPM	LPM
2020-11-02	01	Complete revision; updated for latest HMI interface updates.	LPM	LPM
2021-06-09	02	Vacuum system change; space requirements details added.	LPM	LPM
2021-10-12	03	Cyclone system addition and details added	LPM	LPM
2021-12-23	04	End-correction feature	LPM	LPM
2022-01-15	05	Add Profile Scan function, RFID function; added instructional video link; Maintenance; Slider install, version I update	AA	LPM

E-S4 User Manual © Copyright 2023 by

EILITE SHARPENING INC.

3096-B Bernard Pilon, Saint-Mathieu-de-Beloeil, Qc, J3G 4S5

t. 450 467-3573

info@eliteperformancetech.com



TABLE OF CONTENTS

- 1. FOREWORD 5**
- 1.1. APPROPRIATE USE 5**
- 1.2. INTENDED USERS 6**
- 1.3. INSTRUCTIONAL VIDEO & TECHNICAL SUPPORT 6**
- 1.4. DISCLAIMER OF LIABILITY 6**
- 2. SAFETY INFORMATION 7**
- 2.1. WARNING NOTICE SYSTEM..... 7**
- 2.2. SAFETY RULES 7**
- 2.2.1. BASIC SAFETY 8**
- 2.2.2. SAFETY INSTRUCTIONS FOR THE OPERATOR..... 8**
- 2.2.3. SAFETY INSTRUCTIONS FOR OPERATING PERSONNEL..... 10**
- 2.2.4. SAFETY INSTRUCTIONS FOR MAINTENANCE AND REPAIR..... 10**
- 2.3. SAFETY SIGNS 11**
- 3. TECHNICAL SPECIFICATIONS 13**
- 4. TRANSPORT 15**
- 5. UNPACKING 16**
- 6. INSTALLATION 18**
- 6.1. SPACE REQUIREMENTS FOR SAFE OPERATION 18**
- 6.2. ELECTRICAL REQUIREMENTS..... 19**
- 6.3. LEVELING 19**
- 6.4. INSTALLING THE BLADE POSITIONING SLIDER..... 21**
- 7. MACHINE CAPABILITIES 22**
- 7.1. BLADE TYPES 22**
- 7.2. BLADE LENGTH 22**
- 7.3. BLADE PROFILE HOLDING 23**
- 7.4. EDGE SYMMETRY 23**
- 8. MACHINE OVERVIEW 24**
- 9. SHARPENING HOLLOW (ROH) AND SHARPENING WHEELS..... 25**
- 10. MACHINE OPERATION 27**
- 10.1. POWERING/SHUTTING DOWN MACHINE 27**
- 10.2. MOUNTING BLADES FOR SHARPENING 27**



- 10.3. CHANGING WHEELS..... 29
- 10.4. SHARPENING 31
- 10.5. BLADE TYPES 31
- 10.5.1. FIGURE SKATE BLADE CYCLE 32
- 10.5.2. END CORRECTION FUNCTION 35
- 10.5.2.1. END-CORRECTION > RELEASE 36
- 10.5.2.2. END-CORRECTION > CUSTOM 37
- 10.5.2.3. END-CORRECTION > PICK 38
- 10.5.3. YOUTH SKATES & RECREATIVE SKATES 39
- 10.6. SHARPENING MODES 39
- 10.7. CROSS-GRIND MODE (X-GRIND) 40
- 10.8. SHARPENING PASSES..... 40
- 10.9. STARTING THE SHARPENING CYCLE 40
- 10.10. TEACHING..... 40
- 10.11. FINISHING PASS..... 41
- 10.12. STOPPING A SHARPENING CYCLE..... 41
- 10.13. TOUCH SCREEN FUNCTION KEYS..... 41
- 10.14. PASSCODE (OPTIONAL)..... 42
- 10.15. PARAMETER SETTINGS & HEADING ACCESS..... 43
- 11. STONING 44
- 12. TROUBLESHOOTING 46
- 12.1. TROUBLESHOOTING GUIDE 46
- 12.2. MACHINE ALARMS LIST 48
- 13. MAINTENANCE 50
- 13.1. TYPICAL MAINTENANCE TASKS..... 50
- 13.2. GRINDING WHEEL CLEANING..... 50
- 13.3. DUST COLLECTING SYSTEM..... 52
- 13.4. GREASING LINEAR BEARINGS 54
- 14. PARTS LIST..... 56
- 15. LIMITED WARRANTY 58



IMPORTANT

READ ALL INSTRUCTIONS BEFORE INSTALLING OR USING YOUR SHARPENING SYSTEM

This document contains important safety information, instructions, and necessary operating procedures. The continual observance of these procedures will prevent injury, increase productivity, and extend the life of the equipment.



1. Foreword

Read this user manual before installing or operating the E-S4 sharpening machine.

Damage caused by failure to follow the instructions herein will not be covered by the warranty.

This document is protected in accordance with copyright protection. The transfer and copying of these documents, even excerpts, and the utilization and communication of its content are not permitted, except if this was explicitly authorized by ELITE SHARPENING.

1.1. Appropriate Use

The machine was designed and manufactured exclusively for sharpening hockey, goalie and figure skating blades (appropriate use). Any other use is considered inappropriate. The manufacturer is not liable for any damage resulting from inappropriate use. The user takes full responsibility in such cases.

Appropriate use includes following the operating, maintenance and repair provisions set out by the manufacturer. Any applicable accident prevention specifications and other generally accepted safety and medical regulations must also be obeyed. Any changes to the machine by the user renders manufacturer liability null and void with regards to any resulting damages.



1.2. Intended Users

These operating instructions are intended for professional and non-professional hockey equipment managers, pro-shop technicians and personnel or any other persons who perform skate blade sharpening.

1.3. Instructional Video & Technical Support

For detailed video instructions click on the following link: <https://youtu.be/unwjnbi5Gs>

If you still have questions and to get assistance from our technical support, please contact us at: (450) 467-3573 or e-mail service@eliteperformancetech.com

1.4. Disclaimer of Liability

We have reviewed the contents of this publication to ensure consistency with the hardware described. Since variance cannot be precluded entirely, we cannot guarantee full consistency. However, the information in this publication is reviewed regularly and any necessary corrections are included in subsequent editions.

We constantly try to improve our products and therefore reserve the right to make any changes or improvements we feel are appropriate. We are, however, not obligated to extend these changes or improvements to already delivered machines or devices.

All images, dimensions and weight specifications in the operating instructions are non-binding.





2. Safety Information

2.1. Warning Notice System

This manual contains notices to ensure operator safety, as well as to prevent damage to property. The notices referring to operator safety are highlighted in the manual by a safety alert symbol, whereas notices referring only to property damage have no safety alert symbol. These notices shown below are graded according to the degree of risk.

 DANGER
Indicates that death or severe personal injury will result if proper precautions are not taken.

 WARNING
Indicates that death or severe personal injury may result if proper precautions are not taken.

 CAUTION
Indicates that minor personal injury can result if proper precautions are not taken.

NOTICE
Indicates that possible property or product damage can result if proper precautions are not taken.

2.2. Safety Rules

Sharpening skate blades involves grinding metal. Metal working can be dangerous if proper operating and safety procedures are not followed. As with all machinery, there are certain hazards involved with the operation of the product. Using the machine with respect and caution will considerably lessen the possibility of personal injury. However, if normal safety precautions are overlooked or ignored, personal injury to the operator may result.



2.2.1. Basic Safety

This machine was built according to the latest technology and generally accepted safety rules. However, risks for the user or third parties, or damage to the machine and other material assets, may occur during use if the machine:

- is operated by untrained personnel without proper instructions;
- is not used according to the standard safety regulations in the country where the machine is being used;
- is improperly repaired or maintained.

The machine may only be operated with original ELITE SHARPENING grinding wheels and spare parts. Any use of foreign material is at the risk of the operator and will invalidate the machine warranty.

2.2.2. Safety Instructions For The Operator

- This documentation should be kept in a location where it can be easily accessed. It should be accessible where the machine is being used.
- In addition to the mandatory accident prevention and health & safety regulations in force in the place of use, generally accepted rules for safe and professional work must be observed.
- Operate the machine indoors only. Do not operate in a damp area. See section 6 (Installation requirements) for proper setup and installation.
- Operators must wear the personal protective equipment recommended in this manual, as well as any protective equipment prescribed by local regulations.
- Ensure that the Dust collecting system is operating properly, that the dust bin container is emptied daily, and that the filter is in good condition. See section 13 for more details on maintenance and vacuum filter replacement.
- A fire extinguisher must be installed and easily accessible, close to the machine.
- A first-aid kit must be available and stored within proximity to the machine.
- The operator of the machine must not carry out any alterations, additions or conversions on the machine that may impair safety without prior permission from ELITE SHARPENING.
- Only allow trained employees to operate the machine. Untrained personnel not fully qualified to operate machine may only operate the machine under the constant supervision of an experienced machine operator.



ELITE BLADE PERFORMANCE TECHNOLOGY

Document #: DS4-0026
Revision: 05
Date: 2023-02-28

3096-B, rue Bernard-Pilon
St-Mathieu-de-Beloeil, QC, J3G 4S5
Tel: (450) 467-3573



2.2.3. Safety Instructions For Operating Personnel

- The machine may only be operated by trained personnel.
- The operator is to wear personal protective equipment as prescribed by local regulations.
- The machine should not be operated without its guards.
- Do not operate the machine with a damaged grinding wheel (dropped wheel, chipped, worn out or any other damage).
- Do not operate the machine near flammable materials.
- Do not touch the rotating wheels during operation.
- Do not touch the moving table with your hands during operation and do not place objects on it.
- Do not operate machine with loose clothing.
- The emergency STOP button (E-Stop) ensures immediate switch-off in case of emergency. It is located on the machine control panel.

2.2.4. Safety Instructions for Maintenance and Repair

- Follow regular check/inspection intervals as prescribed in this manual.
- All maintenance and repair works can only be carried out once the main power switch is turned off. Manual interventions on a running machine can lead to serious accidents and are prohibited.
- Ensure safe and environmentally friendly disposal of waste materials (e.g.: steel blade grinding particles, worn grinding wheels) as well as replacement parts.
- Work on the machine electrical system may only be performed by a qualified electrician or electrical engineer and needs to be supervised by an ELITE Blade Performance technician.
- Machine parameters, settings and software are password protected and any changes may only be carried out by an ELITE technician. Unauthorized access and modifications to the software is prohibited, can impair safe operation, can lead to injuries and will invalidate the warranty.
- Correct grounding of the electrical system must be ensured through a protective earth conductor system.





2.3. Safety Signs

 WARNING	RISK OF INJURY!
--------------------------------------------------------------------------------------------------	------------------------

Regular checks must be made to ensure that the warning labels are in place. Illegible or missing warning labels must be replaced immediately.

Learn and recognize these safety signs:

Warning Label	Meaning	Description
	PROTECT YOUR EYES	Wear safety glasses or suitable eye protection when working on or around machine.
	PROTECT YOUR EARS	Wear ear protection for prolonged use. Exposure to loud noise can cause impairment or loss of hearing.
	MOVING PARTS AND PINCH POINTS	Caution Moving Parts! Keep hands away from moving components of the machine when in operation.



Warning Label

Meaning

Description



EMERGENCY STOP BUTTON

In the event of incorrect operation or dangerous conditions, the machine can be stopped immediately by pressing the E-STOP button. Twist the emergency stop button clockwise (CW) to reset.

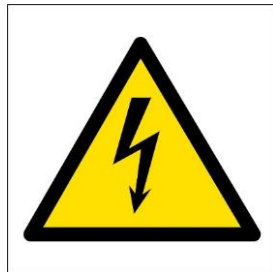

HIGH VOLTAGE, RISK OF ELECTRICAL SHOCKS

Before opening electrical panel, disconnect power supply! Follow proper lockout procedures.

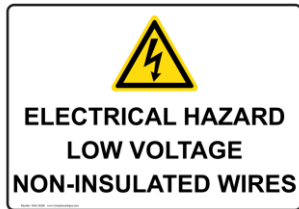

LOW VOLTAGE CONTACT WIRES ONLY

Do not connect live wires to terminal.

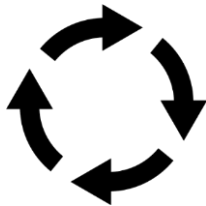

SPINDLE/WHEEL ROTATION DIRECTION

Indicates grinding wheel rotation direction.



3. Technical Specifications

Item	Spec
Nominal voltage, frequency, Full Load Current (FLA), Short circuit current rating (SCCR)	120/240V~60Hz Single Phase, 14.2A, 5kA
Electrical Inlet Type	L1420 NEMA 20A Twist-Lock (Machine Power cord plug is L14-20P)
Allowed ambient temperature	+10 to 30°C
Maximum relative humidity	80%, no condensation
Total weight	Approx. 300 kg [660 lbs]
Grinding wheel diameter	150mm [5.91 in.]
Noise (While sharpening; vacuum system running)	85 dB sound level at 1m [3 ft.]
General dimensions	See drawing below



Document #: DS4-0026
Revision: 05
Date: 2023-02-28

3096-B, rue Bernard-Pilon
St-Mathieu-de-Beloeil, QC, J3G 4S5
Tel: (450) 467-3573

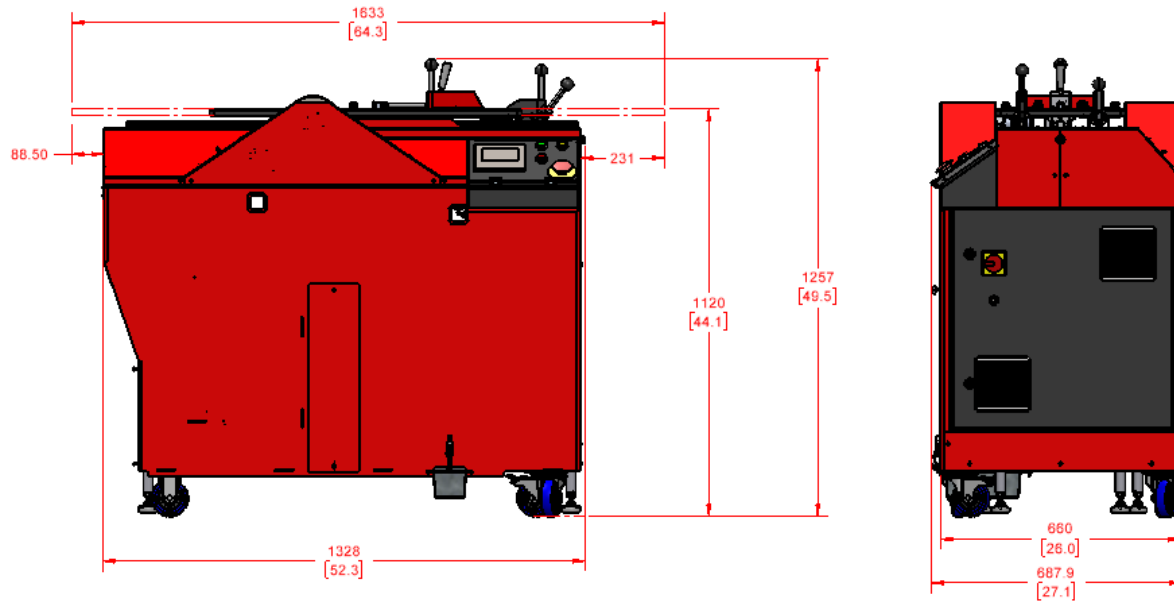



Figure 1: E-S4 overall dimensions.



4. Transport

The E-S4 is packaged onto a wood pallet for easy transportation, loading and unloading.

 WARNING	DO NOT STACK!
--------------------------------------------------------------------------------------------------	----------------------

The machine is not packaged in a way that allows for stacking of other items on top. Uneven surface can lead to fallen objects and injury as well as damaging the machine.



Figure 2: Pallet lifting area.

Packaging design is meant to be handled by either a carry pallet or a lift truck. Carry and lift where shown by arrows.

Place pallet **close to installation location** with enough space to roll machine off the **pallet** and into final position.

Approximate package weight is: **400 kg [880 lbs]**.



5. Unpacking

After receiving your equipment, remove the protective material. Do a complete visual inspection, and if damage is noted, **photograph it for insurance claims** and contact your carrier at once, requesting inspection. Also contact ELITE's Customer Service Department and inform them of the noted damage. Temporarily suspend installation.

NOTICE	Use caution if using knife to remove wrapping.
---------------	------------------------------------------------

Using a knife to remove packaging material can damage the machine. Take care when removing wrapping around the machine.

Follow these general steps to unpackage the machine:

- Unwrap packaging material.
- Cut bundle straps (2x) which are holding down the machine on the wood pallet and remove packaged boxes.
- Lower ramp purposely made to roll down machine as shown:



Figure 3: Pallet roll-down ramp.

- When packed, the E-S4 is dropped onto pallet above two (2) stack blocks. Remove these stack blocks one at a time by gently lifting each side with the help of a crowbar as shown:

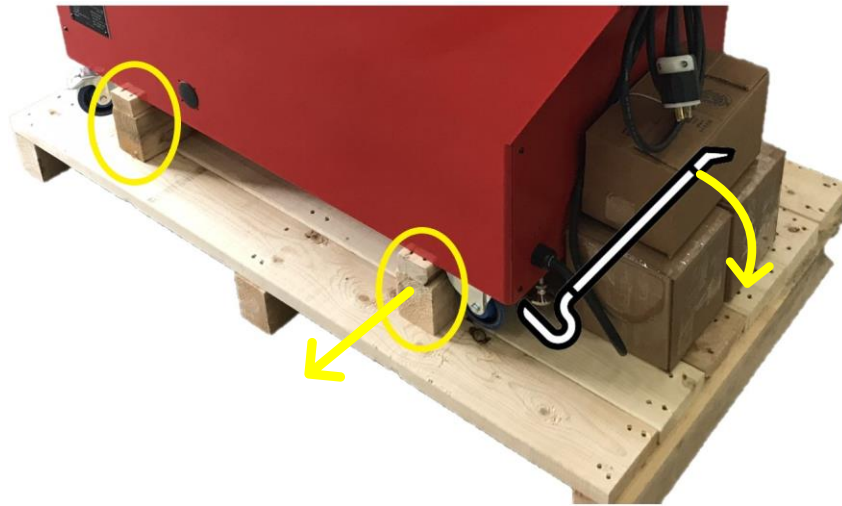

Figure 4: Stack blocks to remove prior to rolling machine off ramp.

 WARNING	HEAVY WEIGHT! ROLLING MACHINE CAN SEVERELY INJURE PERSON!
--------------------------------------------------------------------------------------------------	------------------------------------------------------------------

Minimum 2 persons required! The E-S4 weighs approximately **400 kg [880 lbs]**. Take necessary precautions while unloading and rolling the machine down pallet to avoid injuries. Ensure there is no wall or obstacle where the machine will be rolled down, to avoid getting pinched or crushed.

- Now that the stack blocks are removed and the machine weight is on its 4 wheels, unlock the two (2) lockable wheels (as shown) and with the help of another person or two, **gently roll** the machine down the ramp and off the wood pallet. Roll machine into position. (see section 6.1 for minimum space requirements).

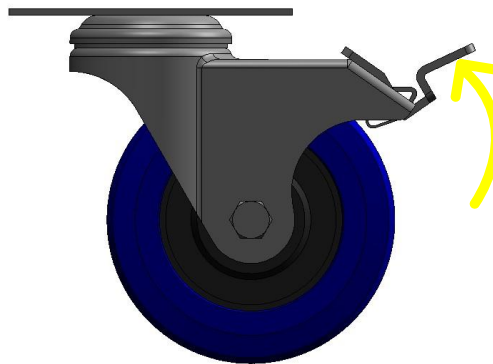

Figure 5: Lift locking tab to unlock wheel rotation.



6. Installation

The E-S4 is intended for indoor installation only. Do not operate or store the machine outdoors.

The machine should be installed on a level and stable surface. Ideally the machine should be installed directly on a finished concrete slab or hard finished floor.

6.1. Space Requirements For Safe Operation

See below drawing for minimum space requirement to ensure safe operation and avoid interference and potential hazard for body part being crushed between moving components and solid objects surrounding the machine installation area:

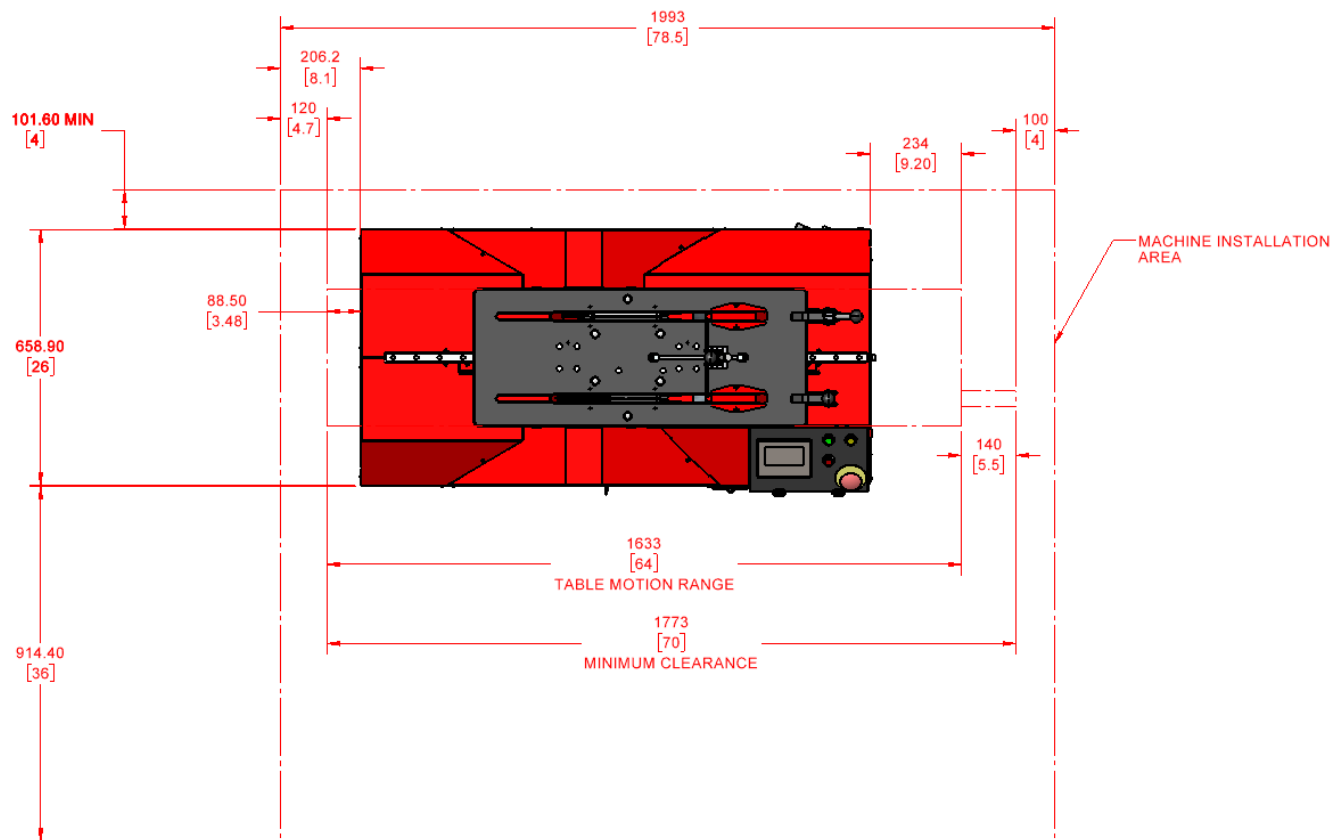

Figure 6: Minimum space requirement for machine location.

Moreover, the electrical panel needs air circulation and a minimum door opening free space. Located at the right-hand side of the machine, there are 2 draft louvers. To ensure adequate ventilation, you must make sure that these air vents are not covered or blocked in any way. An installation that does not meet these minimal requirements will void the warranty.

6.2. Electrical Requirements

Note that one individual outlet is required for each E-S4 installed:

- One (1) 120/240V, Single Phase, 20A dedicated circuit with an L1420 outlet

The electrical outlet should be installed near the machine location to plug its power cord directly to it. The machine power cord is 3.6m [12'] long.

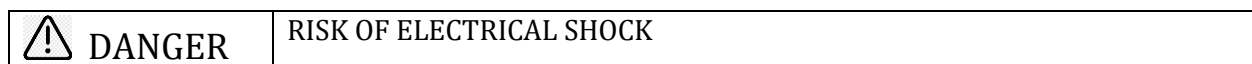

Do not connect the machine to an extension cord.

Installation of the electrical outlets should only be carried out by a certified electrician.



Figure 7: NEMA L14-20 type plug and required outlet.

6.3. Leveling

- Position machine where desired (see section 6.1 for minimum space requirements).
- Place four (4) pucks directly under the machine leveling feet and adjust leveling feet until all wheels lose contact with the ground (all can freely rotate), but no more.

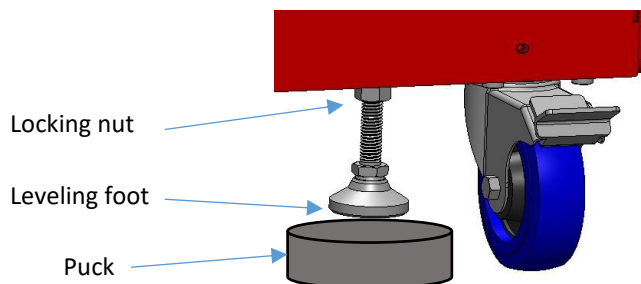

Figure 8: Leveling foot and lock nut. Place standard Hockey puck under leveling feet as shown.

- Level machine in both axes with the four (4) leveling feet (use $\frac{3}{4}$ " or 19mm key wrench) placing level vial where shown.

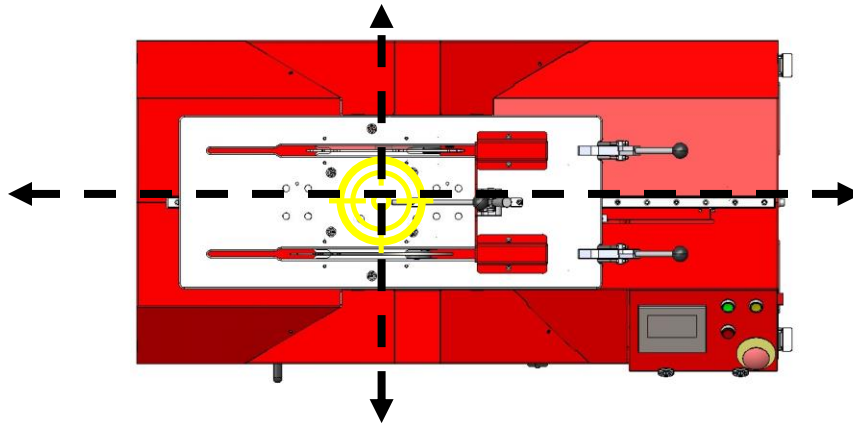

Figure 9: Place bubble level on top of linear table at position shown to level machine in both axes.

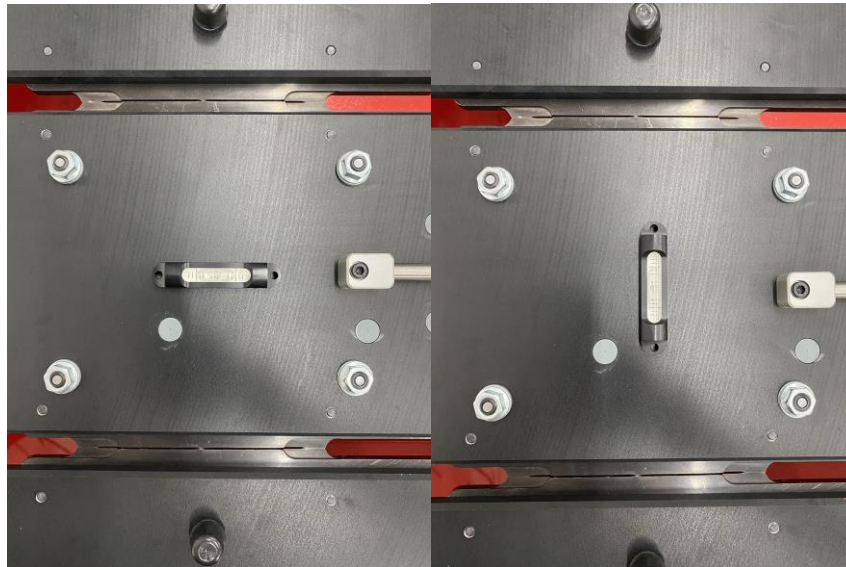

Figure 10: Horizontal and Vertical placement of level vial.

- Use the provided precision level vial or any level sensitive to at least $10\text{min.}/0.050''$ (the lesser the angle per height error, the more sensitive).
- Once the machine is level, lock the leveling feet with the locking nut and recheck the level for both axes.



6.4. Installing The Blade Positioning Slider

The Blade Positioning Slider is removed from the Main Table to prevent damage during shipping. It needs to be installed before operating the E-S4. Follow these steps:

- Unpack the Slider and find the 4mm Allen Key in the provided toolbox.

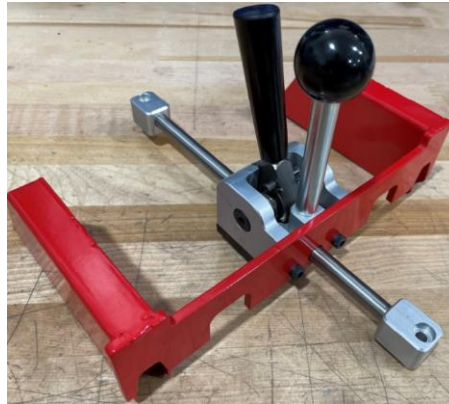

- Remove the hex socket holding screws that are already on the Main Table.



- Insert the Slider under the Wheel cover guards, and position as shown:

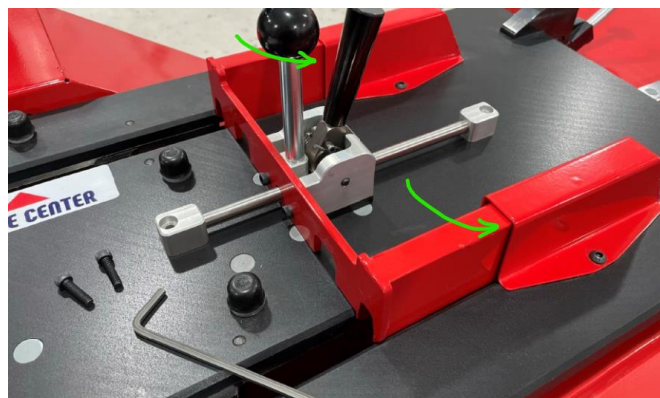



- Insert and tighten both screws taking care not to overtighten.

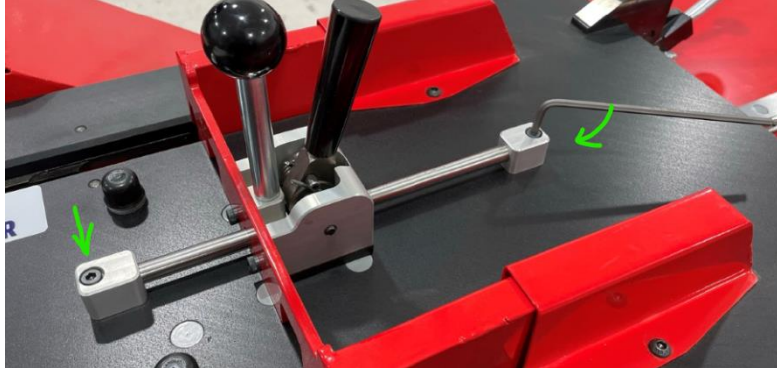

- Check that the Slider works well and without restriction (see section 10.2 for more details on mounting blades and using the Blade Positioning Slider)

7. Machine Capabilities

7.1. Blade Types

The E-S4 is designed to sharpen hockey (goalie & player) and figure skate blades. Never attempt to sharpen any other types of blades (e.g.: Nordic skates, Speed Skating blades or other).

NOTICE	PARALLEL SIDED TYPE BLADES ONLY
--------	---------------------------------

Note that the E-S4 clamping mechanism is not suited for tapered blade (“flared”). Use only flat and parallel sided blades.

7.2. Blade Length

The E-S4 incorporates a powerful blade clamping mechanism which holds blades in place for sharpening. These blade clamps are available in two lengths (option at time of ordering):

- Regular: to sharpen the widest range of blade lengths (minimum Youth size 8 or 200mm).
- Pro: provide superior clamping for longer blades but which cannot be used to sharpen shorter blades (minimum 246mm).

See below table minimum and maximum permissible blade lengths:



Blade Type	Min/Max	Blade Size
Hockey Player	Min	Youth size 8 for Regular clamps or 246mm for Pro ¹
	Max	312mm
Hockey Goalie	Min	Size 1
	Max	Size 13
Figure Skate	Min	Youth size 1
	Max	size 13-1/2

The E-S4 is capable of handling blade width between 2.5 to 4mm [0.080-0.160"] without any adjustment required.

7.3. Blade Profile Holding

The E-S4 will automatically and precisely reproduce the existing profile of any blade. No adjustment by the operator is needed.

7.4. Edge Symmetry

Edge height symmetry will be within .0015" or better (assuming straight blade; within clamp length).

¹ Limited to 246 blades with Pro clamps option (246mm will work with relatively new blades, perfectly centered in clamps; machine may not detect presence of worn and shallow blades in clamp).



8. Machine Overview

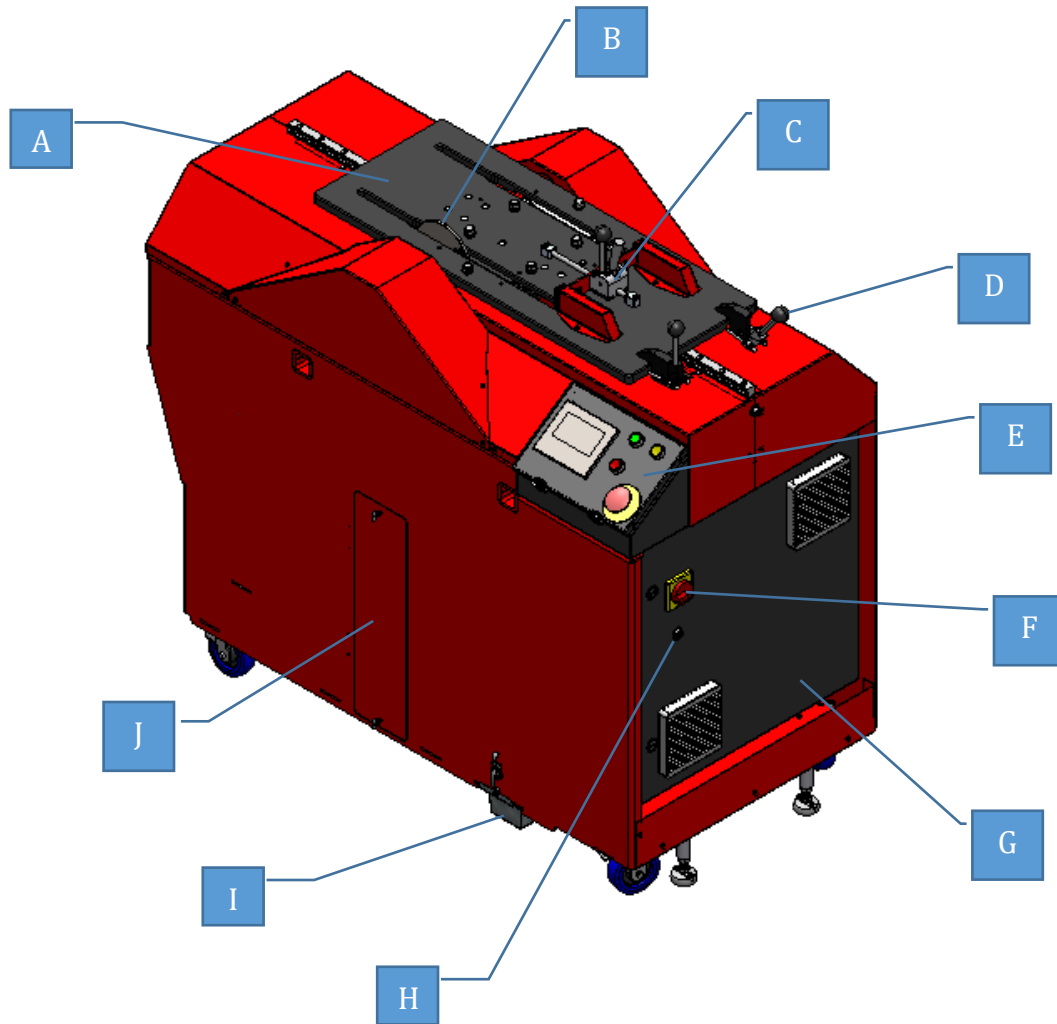

Figure 11: E-S4 machine overview and identification of main components.

A	Main Table
B	Grinding Wheel
C	Blade Position Slider
D	Blade Clamping Lever (X 2)
E	Control Panel
F	Main Power ON/OFF Switch
G	Main Electrical Cabinet
H	Machine Ethernet Communication Port
I	Dust Bin Container
J	Dust Collector Filter Access Door

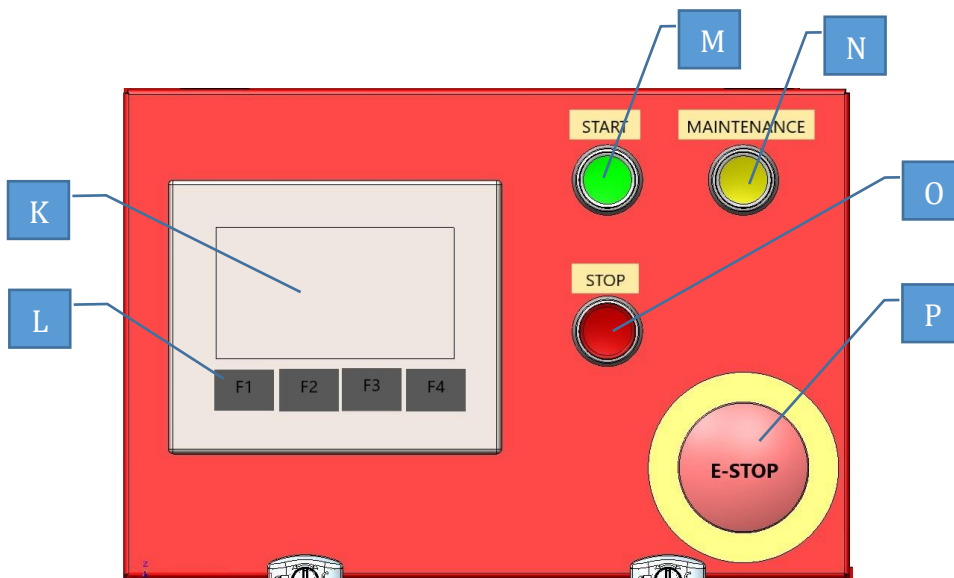

Figure 12: E-S4 Control Panel.

K	Touch Screen control interface
L	Function keys
M	Cycle START button
N	MAINTENANCE button
O	End cycle STOP button
P	EMERGENCY STOP button

9. Sharpening Hollows (RoH) And Sharpening Wheels

The radius of hollow is the depth of the groove cut into the bottom of your skate blade. It is described as the radius of a circle, measured in inches. The larger the radius, the shallower the groove. The smaller the radius, the deeper the groove. The size of the radius of hollow determines the bite you feel on the ice.

With the E-S4, there is no “wheel dressing” involved since the radius of our grinding wheels are precisely machined and never deform or change over time, whatever the level of wheel wear. There is no “wheel dressing” involved with the Elite system – to change the radius of hollow, you simply change the sharpening wheels.

Elite Sharpening offers sharpening hollows ranging from $\frac{3}{8}$ inch to $1 \frac{1}{4}$ inches.

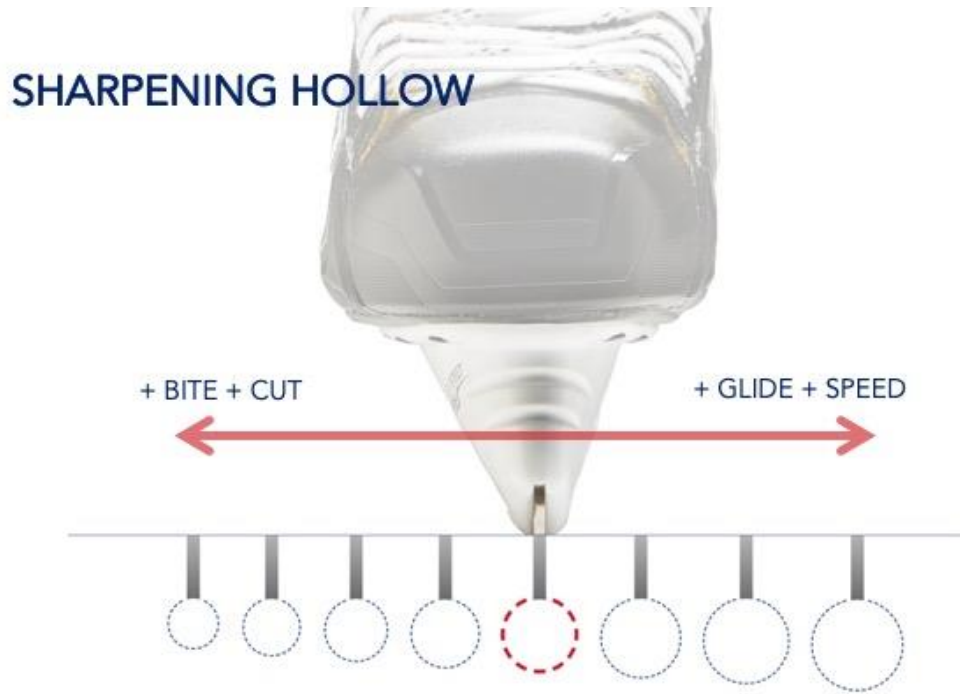

Figure 13: Sharpening Radius of Hollow.



10. Machine Operation

10.1. Powering/Shutting Down Machine

Turning on the machine:

- Turn Main Power Switch to ON (F)
- Reset the E-stop button by turning it counter-clockwise (P)
- Complete sequence lasts less than a minute; machine is ready once sharpening menu appears on touch screen (K)

Shutting down the machine for typical end-of-day routine:

- Press down the E-stop button (P) to cut power on all motors and avoid system from overheating while machine is not in service.

Shutting down the machine for end-of-season or multi-day shut-down:

- Press E-stop (P)
- Turn main power switch to OFF (F)

10.2. Mounting Blades For Sharpening

For optimal sharpening, it is important that blades be level and properly aligned. Always sharpen blades either mounted on skates or on the Elite specially designed Blade Holder (supplied with machine).

- Clean & check blades
 - Before starting, use a straight edge (e.g. metal ruler) to check blade for warping and if necessary, redress with blade straightener.
 - Make sure that blade clamping surfaces (blade sides) are clean and free of debris.
 - To ensure edge symmetry, it is critical that the E-S4 clamps sit directly on the sides of the blades. Clean off any chips or nicks from the plastic skate blade holder which could interfere with proper clamping when mounting a complete skate.
- Position blades inside clamps
 - The E-S4 sharpens two blades simultaneously. It is easiest to start by mounting the blade furthest from the operator, followed by the one closer. (Note: The E-S4 can



sharpen only one blade at a time, but it is always best to sharpen both blades of a pair together to preserve equal blade heights).

- Start by pushing the Slider (C) away from the clamps (to your right)
- Open the furthest clamp (left hand skate) and drop blade inside approximately centered with Blade center sticker.
- Steel on steel. Bring clamps gently in contact with blade without fully clamping to feel clamp contact. Be sure you are not clamping on the plastic blade holder).
- Make sure the bottom of holder sits on top of clamps and the blade sits naturally leveled, taking care not to "rock" it towards the nose or the heel. Just let it sit straight before clamping.
- Holding the blade holder or skate boot in position with your left hand, fully close the clamp lever with your right hand until it latches in place (lever upright). Take care not to pull the lever sideways while clamping.
- Next bring the slider back toward the clamps (depressing the cam lever) until it contacts the toe of the blade holder. This now serves as a guide for mounting the second blade, to ensure that both blades are perfectly aligned. LEAVE THE SLIDER IN CONTACT WITH THE BLADES THROUGHOUT THE SHARPENING CYCLE.
- Now mount the second blade, making sure to seat the toe of this skate or holder against the moving stopper before clamping (to have both skates/blades aligned)

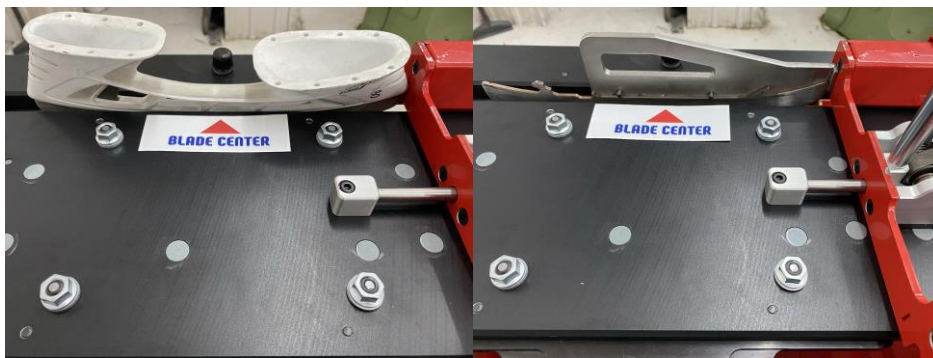

Figure 14: Blade mounted on a skate or holder clamped in machine. Mounting a blade without the skate using the Elite Blade Holder. Note the machine table slider abutting the skate nose or holder end.



WARNING

SHARPENING INVOLVES METAL GRINDING. ALWAYS MAKE SURE TO BRING SLIDER IN CONTACT WITH SKATE OR BLADE HOLDER TO PROTECT YOURSELF FROM FLYING PARTICLES.



10.3. Changing Wheels

With the E-S4 there is no “wheel dressing” involved since the radius of the grinding wheels are precisely machined and never deform or change over time. You simply need to select wheels based on the desired hollow. See section 9 for more information about sharpening hollows.

To install the wheels:

- Press the “Maintenance” (N) button to move the table away and bring the wheels up.
- Unscrew Wheel knobs - turn knobs towards table (if needed, use the provided pin spanner wrench) and gently remove the mounted wheels. Be careful not to torque the swing arm when removing wheels – we suggest you hold wheel in both hands and use thumbs to push against the spindle flange.



Figure 15: Loosening direction. Hold wheel with left hand and loosen knob towards table with right hand.

- Install desired wheels - **Make sure wheels are fully seated onto spindle flange, with the marked side sitting against the spindle flange.**



Figure 16: Proper mounting face. Wheel inscription towards spindle mounting face.

- Screw back wheel knobs snugly by hand, turning the knob away from table. There is no need to overtighten.



Figure 17: Tightening direction. Hold wheel with left hand and tighten knob away from table with right hand.

- Press the yellow “Maintenance” button to bring back table in initial position. Note there must always be two wheels mounted on the machine for it to operate (even if you are sharpening only one blade).

NOTICE	SPECIAL CARE MUST BE TAKEN TO STORE GRINDING WHEELS TO PREVENT DAMAGE FROM BANGING ONE TO ANOTHER. DO NOT STACK WHEELS. USE WOODEN WHEEL CABINET TO STORE.
--------	------------------------------------------------------------------------------------------------------------------------------------------------------------

 WARNING	PERMANENTLY DISPOSE OF A DAMAGED WHEEL THAT WAS DROPPED FROM OVER 30cm [12"] ON A HARD SURFACE!
---------------------------------------------------------------------------------------------	-------------------------------------------------------------------------------------------------



10.4. Sharpening

The sharpening cycle of the E-S4 is fully automated and requires no manual control by the operator. But the operating program does allow the operator to set a number of key parameters to optimize performance and efficiency. The three parameters to control are **Blade Type**, **Sharpening Mode** and **Number of Passes**. These options are all managed through the Touch Screen (K) of the Control Panel (E). See below for details.

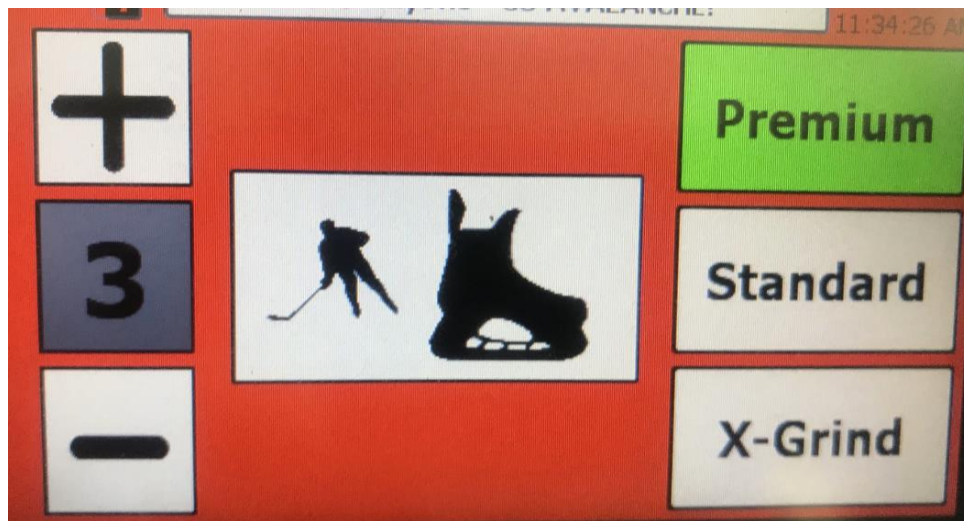

Figure 18: Main control panel screen of the E-S4. Number of sharpening passes (left), blade type program (middle) and Sharpening modes (right).

10.5. Blade Types

The E-S4 has embedded sharpening programs optimized for three (3) blade types – “Player”, “Goalie” and “Figure Skate” - plus an optional “End Correction” function (described below). These are represented by four (4) soft touch buttons in the center of the screen.

The “Player” blade type sharpening is the default program, and this is the icon which will show when the machine first boots up. To change Blade Type, press the middle Blade Type button to access the selection screen showing other types.

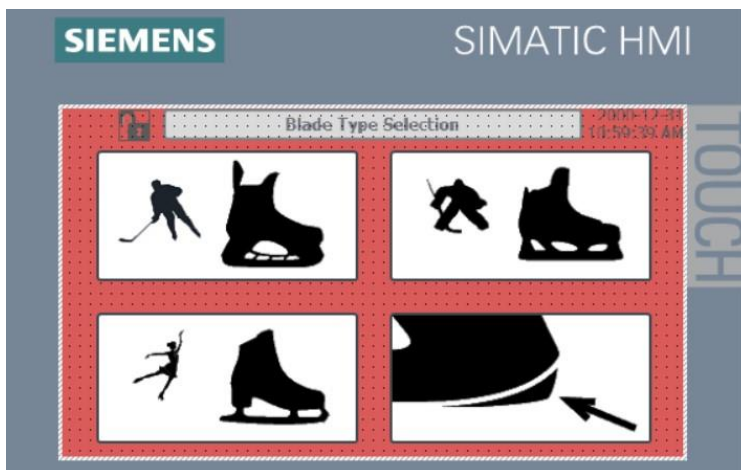

Figure 19: Blade type Program selection buttons on the control panel screen.

- Press the **Player icon** button for all Hockey Player blades (default)
- Press the **Goalie icon** button for all Hockey Goalie blades
- Press the **Figure icon** button for all Figure skating and similar profiles of recreative type skates (optional) (see section 10.5.1 for more details)
- Press the **End Correction** button for blade end-correction (see section 10.5.2)

Note that when Goalie or End-correction Blade type is selected, the machine will **immediately default back to “Player” once the sharpening cycle is completed**. To clearly show that Blade Type has been changed back to default, middle button will flash bright yellow.

Note that the machine will not default back to “Player” with the Figure Blade cycle.

10.5.1. Figure Skate Blade Cycle

The E-S4 has the capability to sharpen Figure skate blades without having to install any protective cover onto the blade to preserve the toe picks and square end of the heel. During the teaching cycle (see Section 10.10 below) the machine will automatically detect the presence of picks and adjust its starting position a few millimetres away from the first toe pick. The sharpening pass will also stop exactly at the apex of the blade’s end, avoiding unwanted chamfering of the heel or rounding its back edge.

To help position both Figure skates symmetrically into the machine’s clamps, use the Elite’s custom Figure blocks as shown below. Secure in place with a 2.5mm Allen wrench (do not overtighten). Clamp blades and bring the Slider against the skate toe as you would with a Player skate (see section 10.2).



Figure 20: Mounting a figure skate blade with the provided Figure Block.

To ensure the sharpening cycle starts as close as possible to (but not contacting) the first toe pick, the grinding wheel will rise to contact the blade at the starting position once the teaching cycle is completed. A pop-up screen will then allow user to adjust this position. Current wheel-blade contact position will be used once hitting the “Continue” button and sharpening will be initiated.

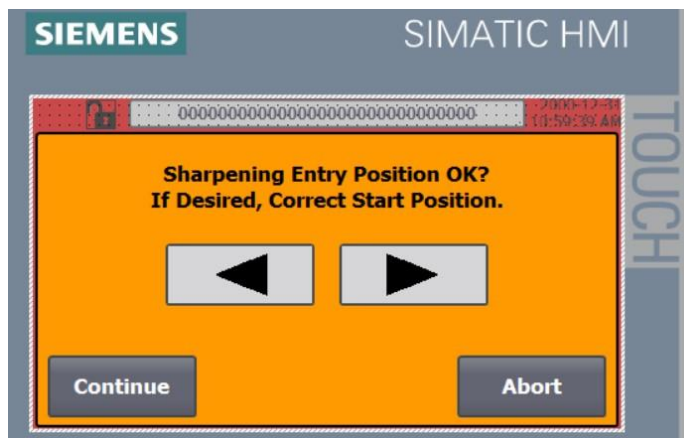

Figure 21: User changeable starting position screen for Figure blade.

NOTICE	GRINDING OF TOE PICKS CAN ARISE FROM SHARPENING WITH BLADE TYPE OTHER THAN FIGURE (i.e. player, goalie)
---------------	---------------------------------------------------------------------------------------------------------

Figure blades are usually expensive and already fixed to the boots, so it is of particular importance to select the Figure blade Type program prior to starting the sharpening cycle.

To help avoid accidentally using the wrong program to sharpen a Figure blade the E-S4 has an embedded Figure blade detection system that operates during the teaching cycle. For example, a Figure blade is present on the machine, but the Player blade type program was



active upon initiating the sharpening cycle. As the teaching cycle ends, the machine will stop, and a warning message will pop-up on the control screen. From there, the user can abort the cycle to make the appropriate selection.

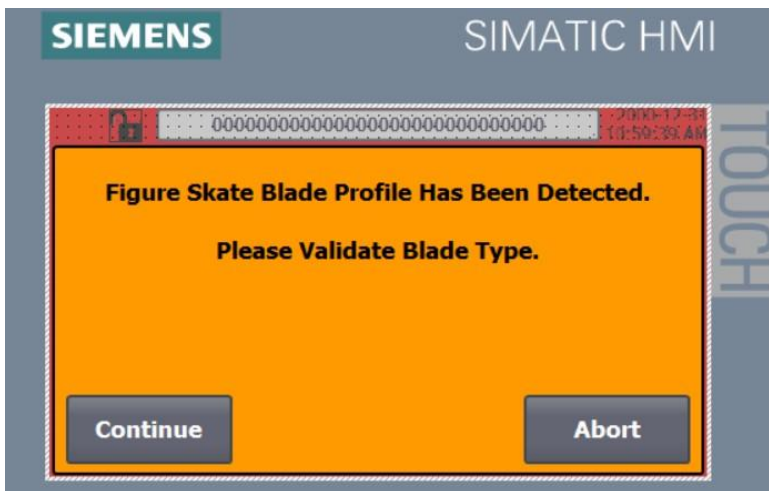

Figure 22: Figure blade detection screen.

Because of the large variety of blade shapes, but also the sensitivity of the machine, very rarely the E-S4 can detect a Figure blade when in fact a Player blade is mounted on the machine. If this happens, simply ignore the warning message, and hit the “Continue” button to start the sharpening cycle.

NOTICE	FIGURE TYPE BLADE AUTOMATIC DETECTION ISN'T 100% CERTAIN
---------------	-----------------------------------------------------------------

Figure skate blade automatic detection is dependent on the figure blade toe picks size and shape and is less sensitive to youth skates with small toe picks. **Elite Sharpening is not responsible for damaged blades arising using the wrong blade type program on the E-S4.**



10.5.2. End Correction Function

The *End Correction* function (selected from the *Blade Type* middle button on the default screen) is a feature meant to modify the geometry of blade ends that can be used for different reasons. When selected, the machine will only tackle a short portion of the blade on the front end or back if blade is reversed. This tool allows customizing the ends of a player’s blades (either toe or heel). It can be used to remove material precisely and consistently from the toe and heel sections of blades for players who prefer more rounded blade ends.

There are 3 options to select from:

1. **RELEASE:** To modify the geometry of the Blade ends (e.g.: remove material either on the Toe or Heel) in order to provide more ‘release’ to the player’s blade ends. Select from 4 levels.
2. **CUSTOM:** To precisely define the blade portion length to tackle/modify.
3. **PICK:** To round an apex present on blade heels (note: mount Blades in reverse direction).

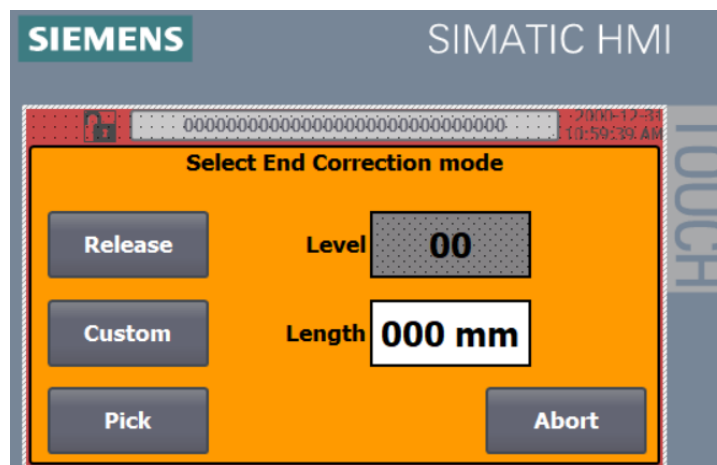

Figure 23: End-Correction function pop-up screen.

Simply mount blades as you would normally for Player or Goalie sharpening cycles. The default sharpening mode with the End-Correction function is **X-Grind**. This allows for a more efficient material removal (fewer passes) and is meant to be used with the dedicated flat “Roughing” wheels, except for the ‘PICK’ option (simply keep the finishing wheels of the appropriate hollow in this case.)

Note that the E-S4 automatically blends-in the sharpened portion with each next pass. The machine will incrementally change each pass exit point in 5mm [0.200”] intervals to avoid ‘steps’ in the blade’s final profile geometry.



10.5.2.1. End-Correction > RELEASE

This option is meant to induce a 'Release' or more curved end portion on a blade's toe or heel. A common application to this feature is when a player changes blade type with the newer blade base geometry offering more end material. This function will make quick work of 'clearing out' the ends of the blades. There are four (4) pre-programmed Levels composed of a succession of sharpening cycles of various number of passes in each cycle. Level 1 removing less material while Level 4 will remove the most. No need to adjust any parameter. To use the function:

1. Clamp the blade with the end you want to tackle facing the Blade Position Slider (C).
2. In the End-Correction Mode screen, select the wanted Level (directly touch the level soft button on the screen to toggle between Levels).
3. Press on the 'RELEASE' grey button to confirm selection.
4. Hit the START button to initial grinding.

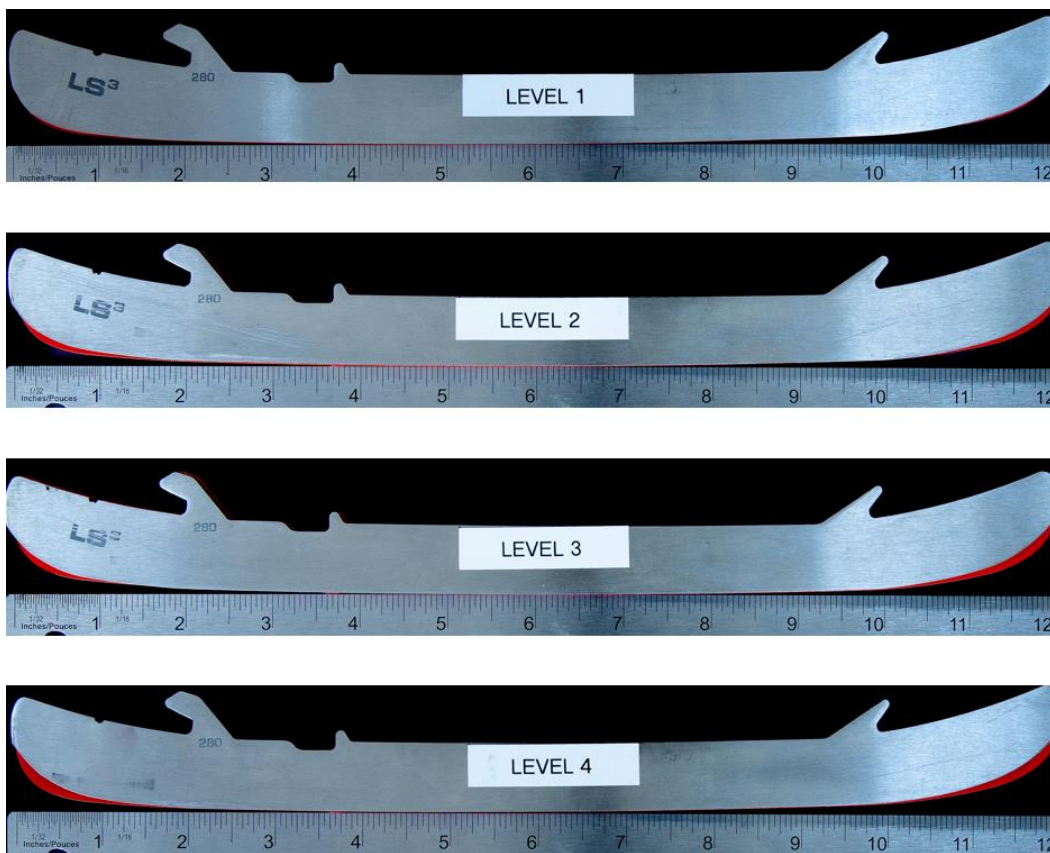

Figure 24: Typical end-release results generated using the 'RELEASE' option (original blade geometry shown in red underneath).



Special note: since there are up to 4 different sharpening cycles pre-programmed in the different levels, the STOP button will only end the current cycle at work, hence you will need to press STOP up to 3 times to end the sharpening cycle after the current pass.

10.5.2.2. End-Correction > CUSTOM

When familiar with the End-Correction mode, this option lets you customize the portion of the blade you want to tackle. This might come when a prominent pick/apex, resulting from a particular profiling operation, needs to be blended-in prior to sharpening.

The CUSTOM option lets you precisely adjust the length of the blade you want to tackle. Simply measure (in mm) the horizontal length from the tip of the blade's end (either Heel or Toe) to the needed exit position (typically a few mm passed the apex you want to blend-in). Enter this numerical value in the 'Length' box. Once adjusted, hit the 'CUSTOM' button to confirm. Adjust the number of passes needed (more passes for prominent apex, less for a small one). Hit START to initiate cycle. As with all the other options, the exit position of each pass will be staggered to avoid inducing any 'steps' on the profile.

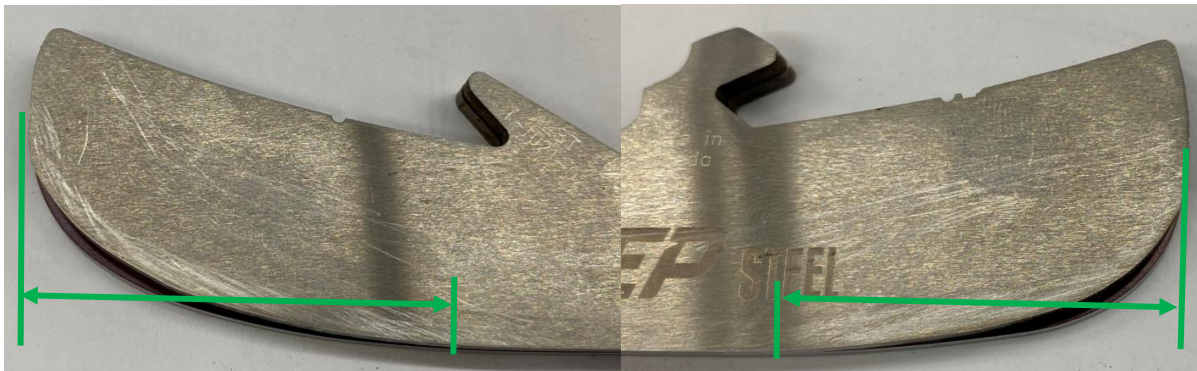

Figure 25: Measuring Toe or Heel apex position for the CUSTOM End-Correction option. Typically add 10mm to this measurement and enter calculated value in the LENGTH box.



10.5.2.3. End-Correction > PICK

To blend a prominent “pick” on the heel of a blade, simply mount blades backwards (heel facing the Blade Position Slider (C)).



Figure 26: Typical result of using the 'Pick' option on a blade having an apex on the Heel.

Simply press on the 'PICK' grey button to confirm selection.

Since the blade portion tackled with the Pick end-correction option is so short, we recommend using the finishing wheel of the wanted hollow even with the X-Grind mode selected. This will result in matching RoH upon conducting a regular sharpening cycle afterwards.



10.5.3. Youth Skates & Recreative Skates

With recreational skates featuring a prolonged nose (figure shown below), place the skate in opposite direction (heel facing Slider) to avoid the grinding wheel contacting/grinding the holder (grinding plastic could



With Youth skates, it could also be advisable to position in opposite direction for similar reasons. When sharpening shallow blade (worn blade or simply short height), using the Goalie blade option can also help in the sense that the grinding wheel will not grind as high on the heel and toe.

10.6. Sharpening Modes

Select from 3 sharpening modes – “Premium”, “Standard” and “X-Grind” – on the right side of the screen. (Default is “Premium”):

- **Premium** => Normal sharpening cycle, for use with all good-quality blades
- **Standard** => Use for low-cost blades and entry level skates. Sharpening parameters adapted to minimize wheel loading (material build-up arising from grinding steel with lower hardness typical with cheaper blades)
- **X-Grind** => “Cross-Grind” mode. To remove any edge and restore a flat bottom on the blades or remove imperfections (nicks, rust...) efficiently (see section 10.7 for more details about this mode)



10.7. Cross-Grind Mode (X-Grind)

There are times when you may want to remove more material than usual, to repair a damaged or poorly formed blade. For example, use this mode if a blade has a particularly deep nick in an edge, or if a new blade has heavy, uneven scale on the bottom. To address this problem, the E-S4 features a Cross-Grind function, which will remove more material per pass, but still perfectly preserve blade profile. This function is meant to be used with Elite “Roughing” wheels which have a flat surface (in other words, no hollow or radius).

To use this function, select and place the Roughing wheels on the spindles, just as you would with normal wheels. Press the X-Grind button on the control screen. We strongly recommend you always use the roughing function on both blades in a pair, even if only one is damaged, to preserve skate blade height symmetry.

Note that the roughing wheels will leave a flat bottom on the blades, so you will have to sharpen them as usual with wheels of the appropriate radius of hollow.

10.8. Sharpening Passes

Since there are several factors affecting the number of passes required to reach full sharpening (blade material and quality, blade width, selected hollow, grinding wheel wear...), this parameter is adjustable at the discretion of the operator. But here are the default number of sharpening passes pre-set for each Blade Type Program which are typical in normal conditions:

- Player blades => 3 passes
- Goalie blades => 4 passes
- Figure Skate blades => 4 passes

Note that once any sharpening cycle finishes, the E-S4 will default back to the pre-set number of passes.

10.9. Starting The Sharpening Cycle

When you have confirmed Blade Type, Sharpening Mode and the desired number of passes, simply press the green Start button (M) and the cycle will begin.

10.10. Teaching

To precisely replicate original blade profile, the E-S4 initially “reads” the blade by sweeping the grinding wheel along its profile. This step takes about 15 seconds in which the table will move back and forth before the actual sharpening cycle starts. This function is embedded in the machine control. No operator input required.



10.11. Finishing Pass

The last pass of a sharpening cycle (whatever the number of passes selected) will be a finishing pass. During this final pass, sharpening parameters (table feed, wheel speed and pressure) are optimized to yield the best possible surface finish. This function is embedded in the machine control and no operator input is required. If only a single pass has been set, it will be a Finishing pass. Note that there is not finishing pass using the “X-Grind” mode (all passes are identical).

10.12. Stopping A Sharpening Cycle

You can stop a cycle at any time during sharpening by hitting STOP button (O). Machine will finish its current pass and stop thereafter.

NOTICE	“STOP” BUTTON DOES NOT IMMEDIATELY STOP MACHINE OPERATION!
--------	------------------------------------------------------------

Should a problem of any kind arise, do not hesitate to press the Emergency-Stop button on the control panel at any time!

To shut-down the machine, see section 10.1.

10.13. Touch Screen Function Keys

There are four (4) function keys (L) at the bottom of the control panel touch screen. As shown:



Figure 27: Touch screen function keys.

Here is a description of each function keys:

- F1 (Skate/Sharpening) => to access main operation sharpening menu
- F2 (Diagnostics page) => to access real-time machine status, axis positions as well as cycle timer (will show exact duration of last sharpening cycle):

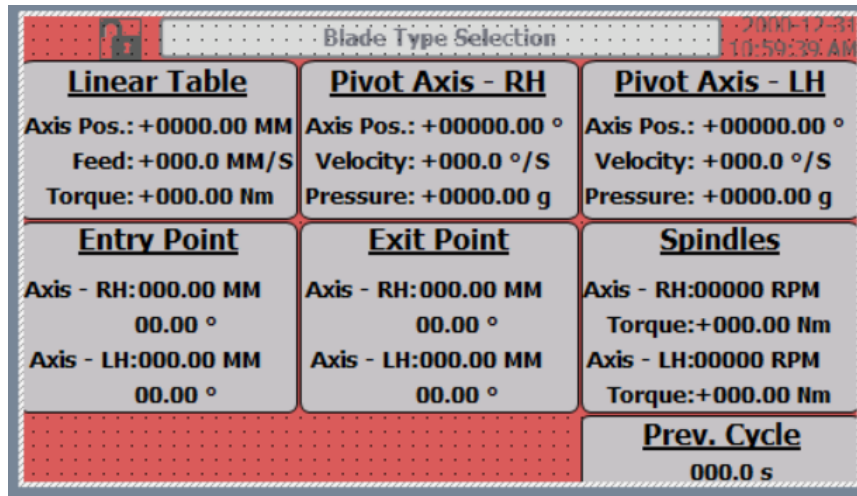

Figure 28: Diagnostics page showing cycle timer (lower right corner).

- F3 (Parameters) => to access machine parameters, tuning and commissioning menus (password protected, see section 10.14)
- F4 (Dust Collecting System) => to manually start/stop the Dust Collecting System.

10.14. Passcode (Optional)

When enabled, the passcode option automatically locks the E-S4 to prevent unwanted access after 5 minutes unused. Once machine is locked, the passcode pop up screen will appear with either pressing the green START button (M) or yellow MAINTENANCE button (N). Touch enter the 4-digit passcode supplied to access. To manually lock the machine, simply hit the E-stop button.



Figure 29: Passcode pop up screen.



10.15. Parameter Settings & Heading Access

To access parameter settings (viewing only – write protected) or to change and customize the machine screen heading, press the F3 button function key (L), touch anywhere on the screen and input the following user and password when prompted:

User: *user*

Password: *scs1*

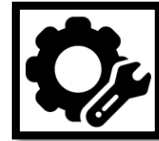



11. Stoning

The E-S4 uses CBN grinding wheels that induce a lot less heat to the blades than traditional sharpening method using aluminum oxide wheels. As a result, blade temper is not affected (wear resistance of the hardened steel state maintained), and edges will last longer. However, the trade-off of less induced heat is a sturdier burr generated along each edge during sharpening that needs to be manually removed.

Important: expect to adopt a different method of edge deburring and conditioning than with traditional sharpening.

 CAUTION	SHARP EDGES! MAY CUT
--------------------------------------------------------------------------------------------------	-----------------------------

Use caution or wear gloves when removing blades from clamps and handling them.

6-steps Elite Stoning Process after removing blades from the E-S4 clamps:

Step	Description	Notes/details
1	Confirm sharpening completion	Make sure a burr is present all along both edges
2	Place blade side face against stoning block	Lean stoning tool on upper face of blade which needs to be stoned
3	Stone (back & forth motion) with <u>ceramic</u> stoning tool	Apply firm but not excessive pressure; be careful not to incline ceramic tool inside!
4	Check to ensure burr is completely removed	Most important! Back to step 3 if any residual burr is found
5	Clean	Use leather cloth or pad along blade length
6	Validate edge sharpness	Slide white acetal stick across edge; check several places along blade length



Figure 30: Stoning process. Blade well seated on blade rest. Use ceramic sweet stick on the side. Use blade side face as reference with care not to “turn the edge in”.

Special notes:

- Elite discourages using a soft type stone to clean off the burr, as multiple back-and-forth strokes will be required, which will quickly groove the stone and lead to rounding the blade's edge.
- Elite recommends the use of ceramic type stoning tool such as a Y-stick (Sweet Stick) used on its side with the handle cut-off. Ceramic is much less susceptible to grooving than soft stones.
- Do not use/apply any finishing compound on the CBN grinding wheels or blades as this will cause wheel loading (clog up the CBN crystals) and reduce wheel life.



12. Troubleshooting

The quality and reliability of the components assembled on an Elite Sharpening machine guarantee near perfect functioning, free from problems. However, if a situation arises, refer to this manual first. If a solution cannot be found, contact our Customer Service department. Make sure you have the serial number and production year of the machine (see on machine nameplate located on the bottom back side). For replacement parts refer to the parts list in section 14.

Our technical staff will do their best to help you get your machine back in working order.

Should a problem of any kind arise, do not hesitate to press the Emergency-Stop button on the control panel!

12.1. Troubleshooting guide

Issue	Problem	Action
Machine will not start (power is on, control panel is lit-up)	E-stop button is triggered	Reset by turning knob counter-clockwise
Machine will not start	No wheels on spindles	Always have wheels mounted on spindles
	Table is outside its normal range	Press E-stop, manually move and reposition table inside normal range, reset E-stop and hit "START" button once more
Wheel starts grinding the Blade position slider (C)	Slider is not pushed all the way towards blade/skate toe/nose	Immediately hit E-Stop, push slider against skate Toe and start back
Single blade detected but two (2) blades in place	One of 2 blades is too shallow or misplaced in clamps and machine is not detecting it.	Reposition misplaced blade; make sure blade fully protrudes outside clamps
No blade detected while blade in place (also see 12.2 Machine Alarms list)	Blade is worn-out. The E-S4 detects a "No-Blade" probably because it is too shallow and presents risk of grinding the clamps	Try repositioning blades to center them; make sure blade fully extends past clamps



Issue	Problem	Action
Excessive force required on toggle lever to clamp skates/blade	You might be clamping the skate holder instead of the blade itself	Make sure clamps are opened just a bit wider than the blade thickness and that the holder (plastic) is sitting <u>over</u> the clamps
Grinding wheel becomes free from spindle or wheel knob unscrews while sharpening	Spindle knob not tightened	Press E-stop, properly tighten wheel knob.
Spindle knob will not come off	Knob was overtightened	Use provided Spanner wrench to release
Excessive vibration and noise while sharpening	Wheels might be "loaded" (material build-up clogging the crystal structure)	Press the maintenance button to access wheels, rotate wheel by hand to find build-up material; remove with sharp metal pick. Press "Stoning" on the touch screen and clean wheels with abrasive rubber stick (see Section 13.2 below)
	Worn-out/damaged wheel	Replace wheel
	Sharpening low-cost steel	Use the "Standard" mode
Edge symmetry apparently exceeding .002"	Improper mounting of the grinding wheels onto spindle	Make sure that spindle flange and wheel face are clean. Fully seat grinding wheel onto spindle flange; place correct wheel side facing flange.
	Warped blade	Straighten holder/blade prior to sharpening with blade straightener
	Improper blade clamping or foreign material on clamps	Make sure clamps are contacting blade faces only. Clean and keep clean clamp contact areas
Sharpening does not start simultaneously (left and right)	Blades are not properly aligned and/or not leveled	Improve blade alignment and/or level (reposition blades); blade position slider should contact blade nose on both sides



Issue	Problem	Action
Blade moves while sharpening, triggering a “Blade move” alarm (also see 12.2 Machine Alarms list)	Improper clamping	Clean clamp contact faces, check blade holder for plastic chips and make sure you are not clamping any part of the holder, reposition blade and clamp
	Poor wheel condition, either worn, or clogged (also see section 13.2)	Clean wheel with abrasive rubber stick in Maintenance mode or retire wheel
Old Goalie cowlings interfering with table hardware; difficult to place	Some large Goalie cowlings can interfere with table hardware when centered in clamps	Play with different skate position until no interference (even if blades are not centered in clamps); use blade holders
Dust collecting system will not start	Clogged Filter	Replace Filter (see section 13)
	No Filter inside machine	Install Filter and close Filter door

12.2. Machine Alarms List

Alarm ID	Alarm message	Troubleshooting
33	Table Travel Limit reached	Table went out of range. This might be caused by a long blade being off centered in clamps. To reset alarm: 1. Press E-Stop button 2. Manually reposition table in middle range 3. Reset E-Stop button 4. Acknowledge Alarm 5. Press Start button
34	Table Interference or Overload detected	Table motion was obstructed. Keep hands and objects away from table during operation. Make sure no foreign object is obstructing full range of motion. Acknowledge alarm and press Start button to resume.
35	No Blade Detected	No blade detected in clamps. If alarm was triggered with blade(s) in clamps, either blade(s) is worn out (blade height is out of range) or not clamped correctly. Acknowledge Alarm to resume.



50-51	Clamp interference detected (RH/LH side)	Interference between right-hand grinding wheel and clamps detected. Try to reposition blade, make sure steel extends past clamps. Blade is either worn-out (insufficient height to extend past clamps) or mispositioned. Make sure full blade profile is extending below clamps. Acknowledge alarm to resume.
52-53	RH/LH Blade Moved.	Right/Left Blade has moved. Caused either by poor grinding conditions (excessive vibrations during sharpening) or incorrect blade clamping. Check wheel (build-up). Troubleshooting: 1. Select the "Standard" mode if sharpening low-cost blade. 2. Check Grinding wheel. If vibration was noticed, wheel could be "loaded" or worn-out. Clean wheel (see section 13.2) or change. 3. Check clamping. Make sure blade cannot be moved by hand. If so, clean clamp/blade contact areas. Make sure clamps are not squeezing the holder. Acknowledge Alarm to resume.
40 to 49	Axis Fault & Axis Technology Object Fault.	Machine fault detected. To reset: 1. Press E-Stop button 2. Shut Main switch off 3. Wait 10 sec and restart machine as usual Contact Elite Service dept. if fault happens again.
39	Dust Collector: Change Filter!	The dust collection filter need to be replaced. To do so: 1. Open the filter door 2. Take the clogged filter out and discard 3. Insert a new filter in the correct position, the flow arrow directing the side opposing the electrical panel 4. Close the filter door
54	Not Spindle Nut detected	Wheel Nut not mounted on spindle. Mount wheel nut.
55	No filter detected	No filter has been detected in the system. If no filter was installed: 1. Open the filter door 2. Insert a filter in the correct position, the flow arrow pointing left 3. Close the filter door



13. Maintenance

Your machine is designed and manufactured to work smoothly and efficiently. Following proper maintenance instructions will help ensure this. Only use original spare parts, and most importantly, **DO NOT** make any modifications to the machine.

13.1. Typical Maintenance Tasks

Machine component	Maintenance task	Frequency
Table	Vacuum/wipe off any accumulated and free metal dust	Daily
Clamps	Open clamps and wipe off dust from clamp contact area with clean rag; check for dents and nicks	Daily
Dust Collector	Empty Dust bin	Daily
Spindle	Remove wheel and wipe-off dust from flat mounting face with clean rag; check for dents and nicks	Weekly
Wheel duct	Vacuum accumulated metal dust inside duct	Monthly
Dust Collector	Replace Filter	Yearly
Linear Bearings	Grease the linear Bearing Blocks situated under the Main Table (see section 13.4)	Yearly

13.2. Grinding Wheel Cleaning

For different reasons and more often with cheaper blades (softer steel), blade material can get caught between the abrasive crystals of the grinding wheels (called wheel loading) causing them to vibrate and generate poor surface finish. Follow this procedure to clean a loaded wheel:

- Stop the machine
- Press “Maintenance” button
- Take the supplied abrasive rubber stick
- Press the “Press & Hold” button on the control panel screen and gently touch the problematic wheel with the stick while in rotation. This will likely un-clog foreign material from the crystal mesh
- Release the “Press & Hold” button, inspect wheel and repeat if needed.



Figure 31: Maintenance wheel cleaning mode pop-up screen.

- If this operation does not seem to remove a large clogged “patch”, gently scrape it off with a metal pick or knife blade (wheel not rotating). This will not damage the wheel crystals.



Figure 32: Small patch of metal stuck to the wheel crystal; referred to as “wheel loading”. This can be caused by poor steel quality and create vibration during sharpening. Remove by gently scratching off with metal pick or knife.



13.3. Dust Collecting System

 WARNING	FAILURE TO CHECK AND EMPTY DUST BIN CONTAINER EVERY WEEK CAN LEAD TO SYSTEM DAMAGE.
--------------------------------------------------------------------------------------------------	-------------------------------------------------------------------------------------

 DANGER	CONTINUE USE OF SYSTEM WITHOUT FILTER OR CLOGGED FILTER CAN LEAD TO SYSTEM DAMAGE AND EVEN CAUSE FIRE!
-------------------------------------------------------------------------------------------------	--------------------------------------------------------------------------------------------------------

The E-S4 dust collecting system is composed of a Dust collecting integrating a cyclone dust separator, a filter and dust bin container. The cyclone uses centrifugal force to separate over 99% of fine dust from the airstream before it ever reaches the system filter, significantly extending lifespan of the filter and preventing suction loss.

It is important to dispose of accumulated metal dust daily. Follow these simple guidelines to keep the dust collecting system in good operating conditions:

1. Empty dust bin every day:

- Release the securing bin latch.
- Slide the dust bin container out.
- Dispose dust in normal garbage.
- Insert back dust container and replace securing latch.

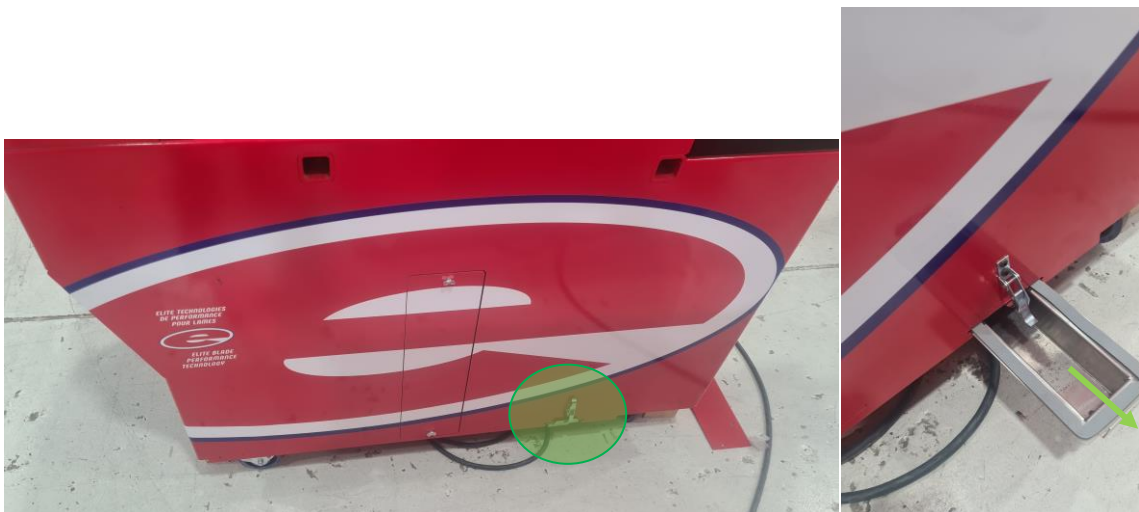

Figure 33 : Emptying Dust Bin.



2. Replace the dust collection filter every month:

- Open the Filter Door and remove the filter.
- Replace with a new filter (make sure the filter is correctly oriented with the air flow arrow pointing to the left); mark installation date where shown.

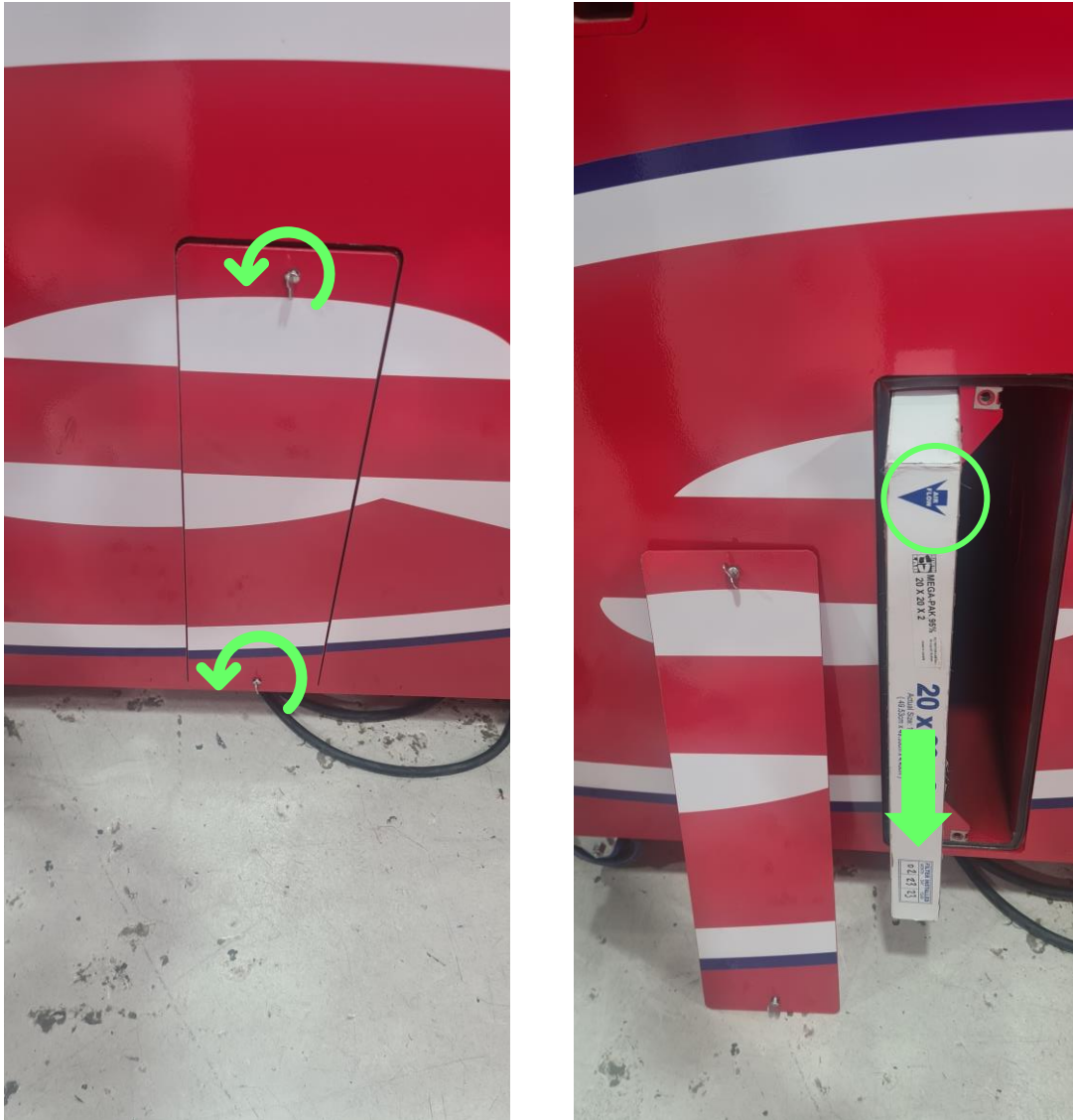

Figure 34: Replacing the Dust Collector Filter.



13.4. Greasing Linear Bearings

Once a year, grease the Linear Bearings (2) located below the Main Table. Only use Elite's specific E-S4 bearing grease.

Find the grease nipples located on each end of both Bearings and follow the following steps:

- Press E-Stop on the control panel.
- Manually slide the Main Table all the way to the left for better accessibility to the grease nipple.
- Wipe-off clean the left-hand linear bearing grease nipple tip as shown on the figure below:



Figure 35: Grease nipple of the left-hand Linear Bearing.

- Fully insert the grease gun into the grease nipple tip (firm pressure required)

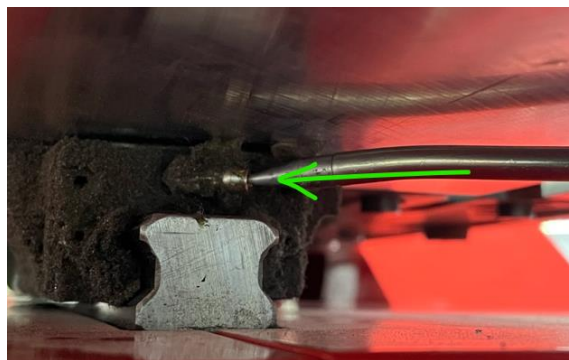

Figure 36: Insert grease gun tip inside grease nipple.

- Fill-in grease by fully depressing the gun's push knob 5 times (Note: grease should not come out of the nipple. If so, this means the grease did not go inside the Bearing).

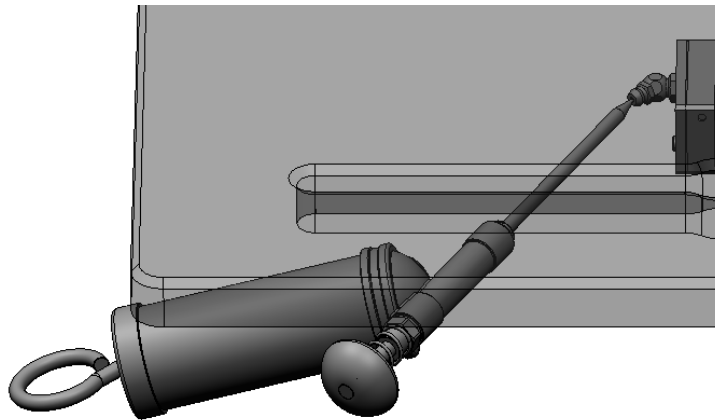

Figure 37: Greasing the left-hand Linear Bearing.

- Wipe off any excess grease.
- Slide the table all the way to the right and do the same procedure for the right-hand Linear Bearing.



Figure 38: Right hand Linear Bearing grease nipple.

Now manually move the Main Table back & forth a few times to get the grease to penetrate the bearings. It should now move much more freely than before.



WARNING

FAILURE TO USE ELITE E-S4 SPECIFIC GREASE WILL VOID WARRANTY.



14. Parts List

Consumables

Part description	PN
Acetal stick (to check blade edge sharpness)	502-10012
Abrasive rubber cleaning stick	550-10001
Stoning tool (Y-type sweet stick)	550-10025
Grinding wheel Roughing (flat)	EV3-5001A
Grinding wheel RoH 3/8	EV3-5001C
Grinding wheel RoH 7/16	EV3-5001D
Grinding wheel RoH 1/2	EV3-5001E
Grinding wheel RoH 9/16	EV3-5001F
Grinding wheel RoH 5/8	EV3-5001G
Grinding wheel RoH 11/16	EV3-5001H
Grinding wheel RoH 3/4	EV3-5001I
Grinding wheel RoH 13/16	EV3-5001J
Grinding wheel RoH 7/8	EV3-5001K
Grinding wheel RoH 15/16	EV3-5001L
Grinding wheel RoH 1	EV3-5001M
Grinding wheel RoH 1-1/8	EV3-5001N
Grinding wheel RoH 1-1/4	EV3-5001O
Dust collector Filter	550-10036



Document #: DS4-0026
Revision: 05
Date: 2023-02-28

3096-B, rue Bernard-Pilon
St-Mathieu-de-Beloeil, QC, J3G 4S5
Tel: (450) 467-3573

Replacement parts

Part description	PN
Replacement clamping lever ASM	EV3-3300A
Spindle Knob RH	EV3-5002F
Spindle Knob LH	EV3-5502F

Tools & Accessories

Part description	PN
Wheel knob spanner wrench	550-10009
2.5mm Hex Screwdriver for Figure block	550-10024
Elite Grease Gun	550-10044
Blade Holder	BH1-0000A
Figure blade block	FB1-0001A
Stoning Block	SB1-0000A
Wheel cabinet	EV3-0102A
Wheel cabinet stand	TM1-0000A



15. Limited Warranty

Elite Sharpening warrants to the original end-user that the Goods manufactured or provided by Elite Sharpening under this Agreement shall be free of defects in material or workmanship for a period of twenty four (24) months from the date of purchase, provided that the Goods are installed, used, and maintained in accordance with any instruction manual or technical guidelines provided by Elite Sharpening or supplied with the Goods, if applicable.

The original end-user shall be responsible for all costs and expenses associated with either returning the Goods to Elite Sharpening or travel associated with repair or replacement of defective Goods where installed for warranty service.

The original end-user must give written notice to Elite Sharpening of any suspected defect in the Goods prior to the expiration of the warranty period. The original end-user must also obtain an RGA (return goods authorization) from Elite Sharpening prior to returning any Goods to Elite Sharpening for warranty service under this paragraph. Elite Sharpening will not accept any responsibility for Goods returned without an RGA.

In the event of a defect, Elite Sharpening, at its sole option, shall repair or replace the defective Goods or refund to the original end-user the purchase price for such defective Goods. The foregoing warranty is Elite Sharpening's sole obligation, and the original end-user's exclusive remedy, with regard to any defective Goods. This limited warranty does not apply to: (a) periodic or routine maintenance and setup, (b) repair or replacement of the Goods due to normal wear and tear, (c) defects or damage to the Goods resulting from misuse, abuse, neglect, or accidents, (d) defects or damage to the Goods resulting from improper or unauthorized alterations, modifications, or changes; and (e) any Goods that has not been installed and/or maintained in accordance with the instruction manual or technical guidelines provided by Elite Sharpening.